

# KSSL060

---

## ASSEMBLY INSTRUCTION

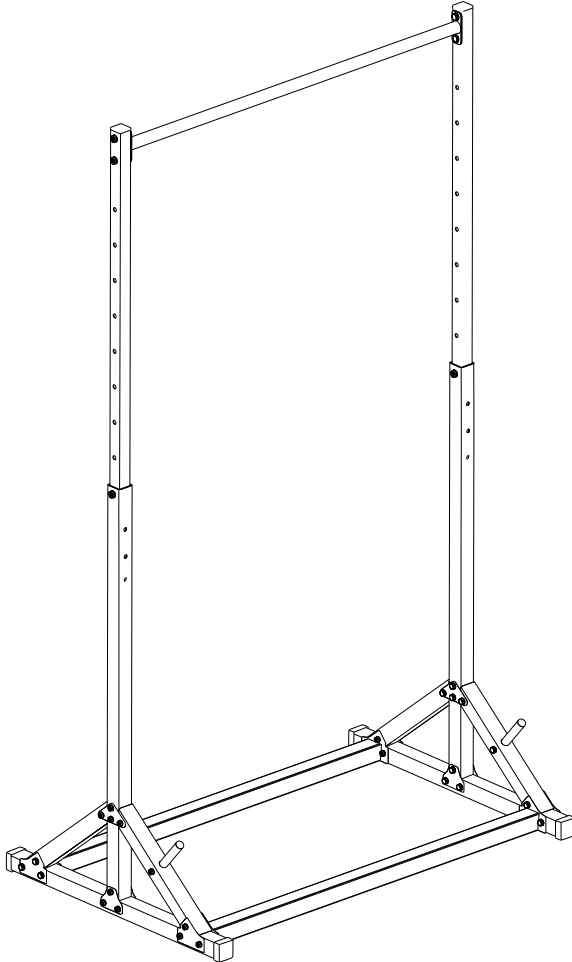

**K<sup>®</sup>SPORT**

[WWW.K-SPORT-DE.DE](http://WWW.K-SPORT-DE.DE)

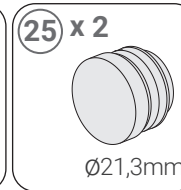
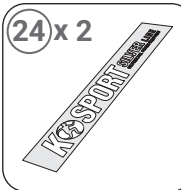
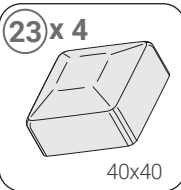
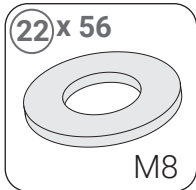
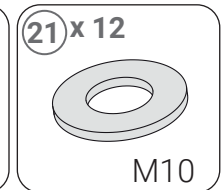
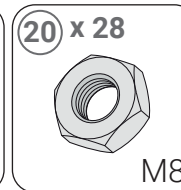
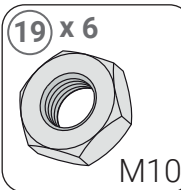
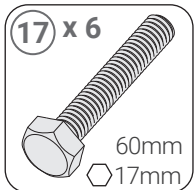
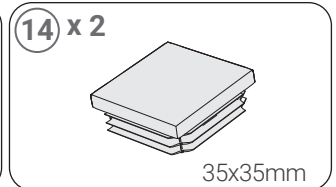
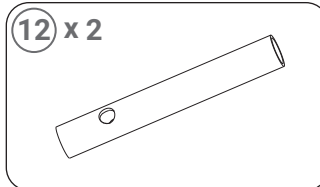
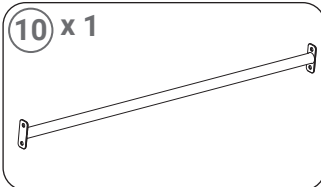
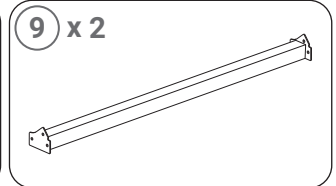
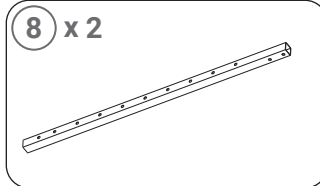
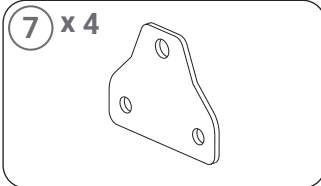
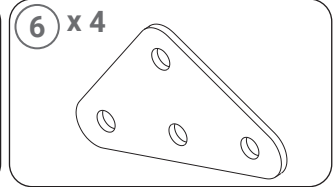
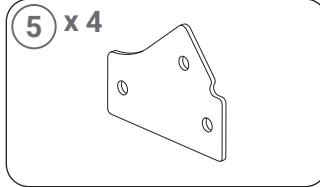
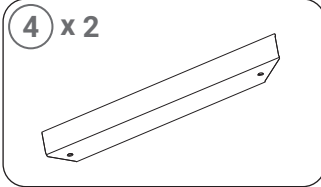
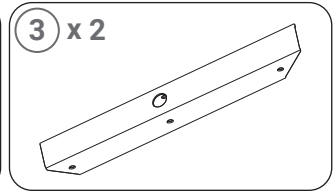
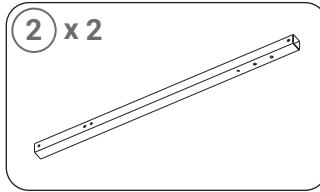
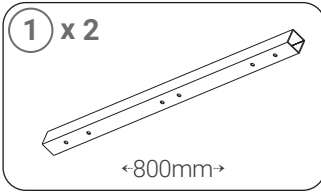

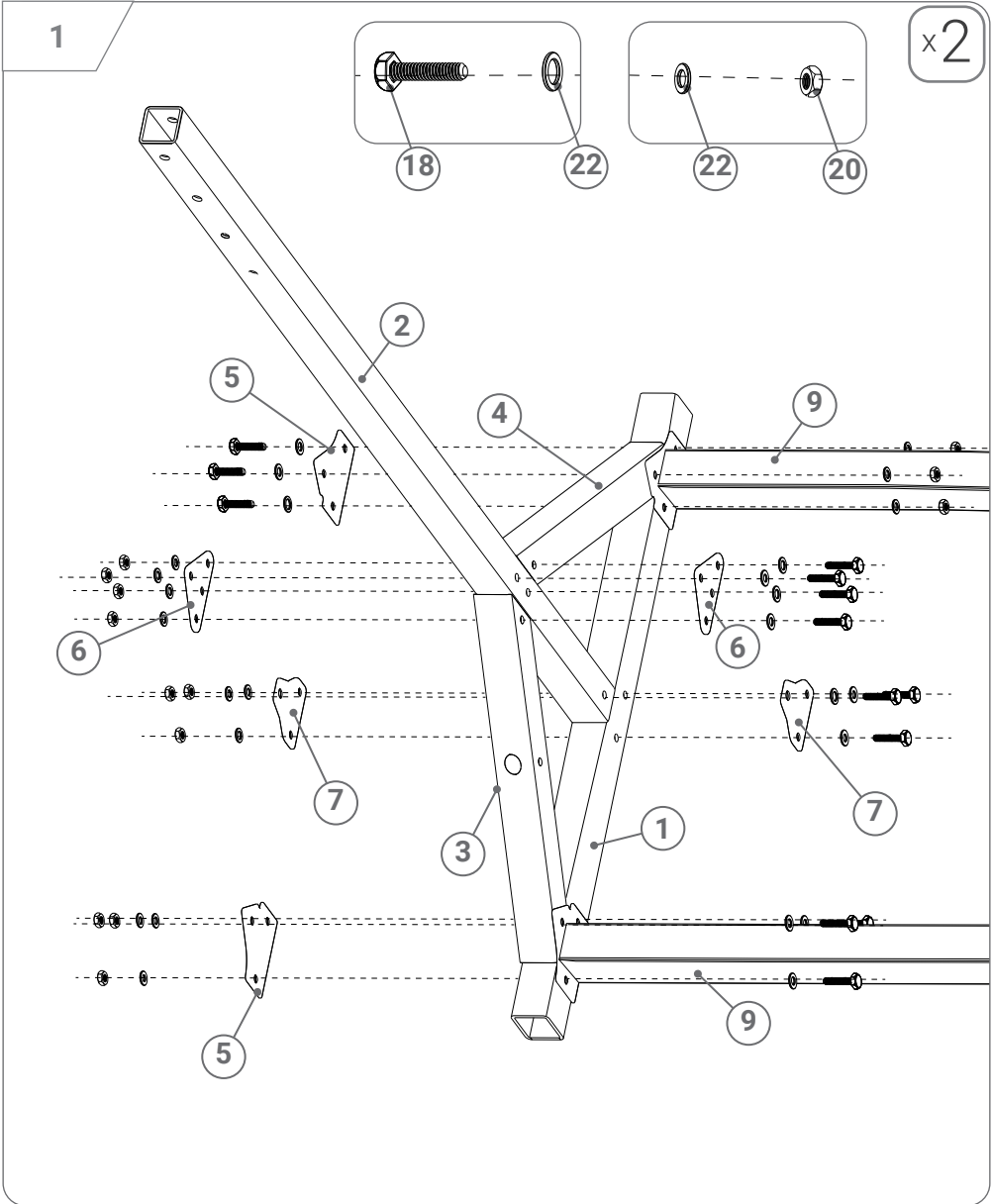
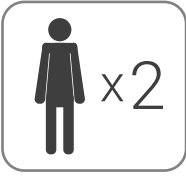

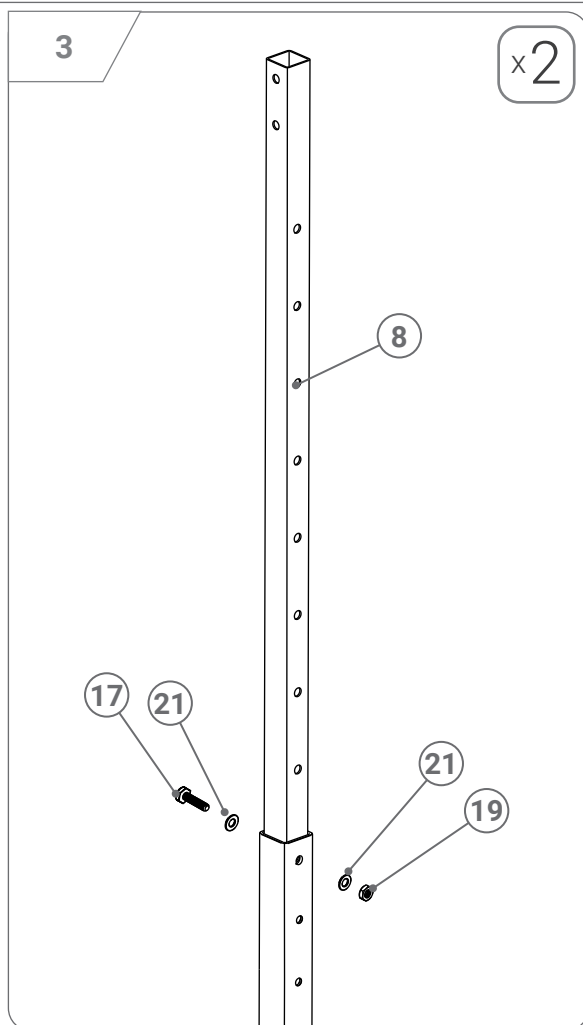
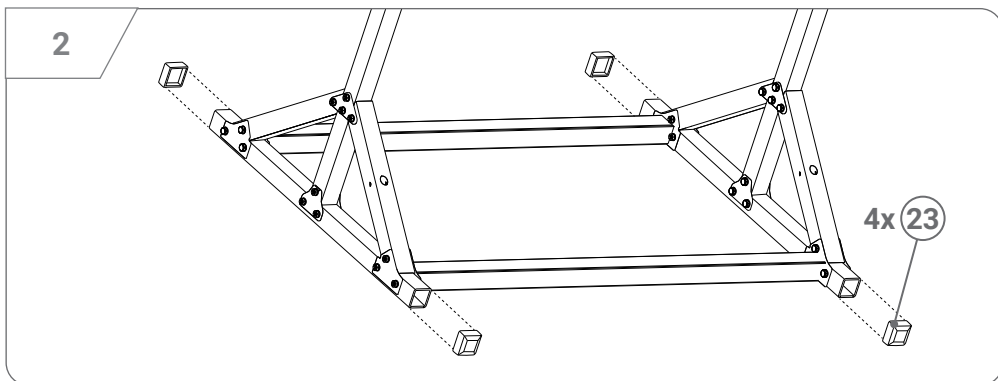

4

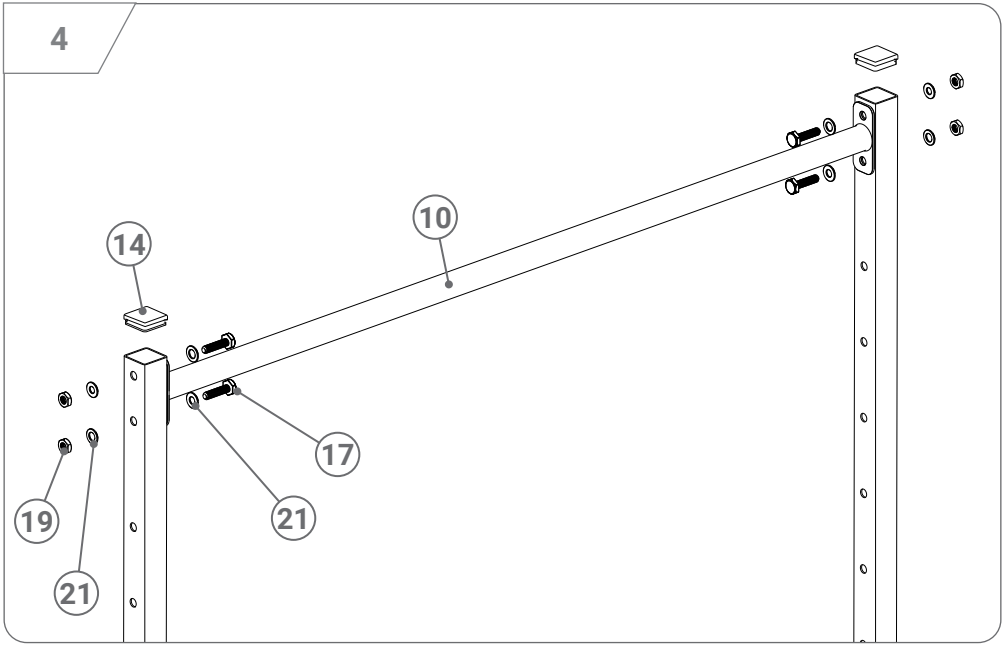

x2

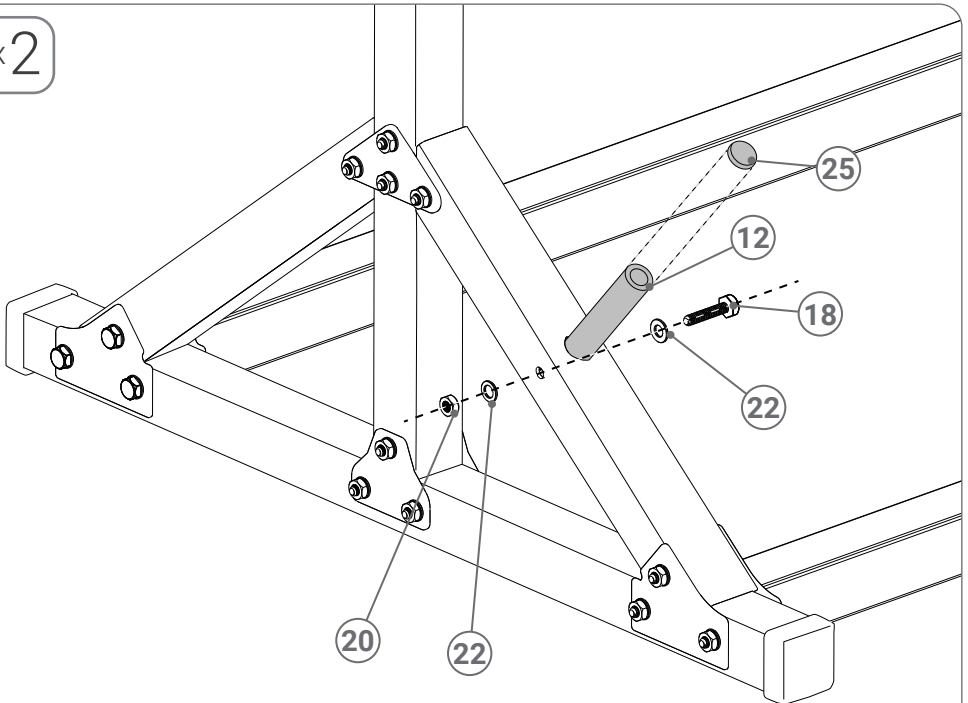

# IMPORTANT SAFETY INFORMATION

## SAFETY

Product designed for a non-commercial use. **BEFORE USE, READ THE INSTRUCTIONS. ALL THE CONDITIONS MENTIONED BELOW SHOULD BE MET.**

1. Before the training, make sure to warm up your body to prevent injuries.
2. Consult a doctor to establish any contraindications to the workout. It is very important in case of a heart disease, blood pressure disorders and cholesterol related problems. Doctor's decision is essential if you are being treated or take medications for a condition that may constitute contraindications for using the device.
3. The device should be placed on the even and stable surface.
4. If the device makes odd noises, creaks – refrain from further exercises. If during the training any distressing symptoms appear (sudden pain of any part of your body), consult a doctor. Exercises done incorrectly may lead to a disability.
5. The device should be secured against children access.
6. There should be at least 0,6 m of free space around the device to ensure easy way out and access in case of an accident
7. Before you begin using the device, check if the machine is working. Make sure to tighten all screws. Inspect the unit including hardware and cables. All the consumables should be replaced after they have been worn out.
8. The device can be used only if it is fully operational. Contact us if you notice any incompatibility. Do not continue any further exercises till the problem is fixed.
9. This product is for adults only. Children can use it only with the adult's supervision on his own responsibility
10. Do not put anything beside parts mentioned in the assembly instruction in the apertures.
11. Be aware of any protruding parts and of regulation mechanisms which could disrupt your training.
12. The device should be used in line with the manual included.
13. Wear suitable clothing during the workout. Loose clothing may get caught in the equipment, resulting in the injury.
14. The equipment is designed for non-commercial use. Using it for any other purpose is not allowed.
15. To avoid injuries, make sure to use proper lifting techniques during lifting or moving the device. Ask for the assistance if it is necessary.
16. The device should be assembled according to the manual. If the equipment does not include all the parts included in the manual, contact the manufacturer on the given e-mail address: [biuro@k-sport.com.pl](mailto:biuro@k-sport.com.pl) providing us with the number of the missing parts.
17. If the assembly of the device is not possible because of the technical errors (missing or misplaced holes, uneven parts), contact us on the given e-mail address: [biuro@k-sport.com.pl](mailto:biuro@k-sport.com.pl). In the message include photos of defected parts.

**WARNING:** We do not take responsibility for damages caused by improper use of the equipment or failure to follow the instructions.

**MAINTENANCE:** To keep the device clean, wiping it with a soft, clean cloth is recommended after each use to get rid of a sweat, dust or other residue. Do not use harsh chemicals, cleaning solvents or strong detergents to clean. To prevent rusting of the equipment, keep it in low-moisture environment.

**Warm up:** Warm up is necessary to prepare your body for training. It raises body temperature, which reduces the risk of the injury. Below we listed few examples of exercises that will help you to get ready for your training. Repeat each of them for at least 30 seconds.



Manufacturer:  
K-Sport Poland  
[K-SPORT.COM.PL](mailto:biuro@k-sport.com.pl)  
Rzepiennik Biskupi  
214, małopolska  
(48) 731 400 995  
[biuro@k-sport.com.pl](mailto:biuro@k-sport.com.pl)

Distributor:  
K-Sport UK LTD.  
Unit 16 Fleets Industrial Estate  
BH15 3SU Poole  
+44 7549 4959 94  
[info@k-sport-uk.co.uk](mailto:info@k-sport-uk.co.uk)